

□ **GLL-730CJP**

□ **GLL-730BNJP**

gemline

Single Handle Tub & Shower Trim Kit

Product Spec Sheet

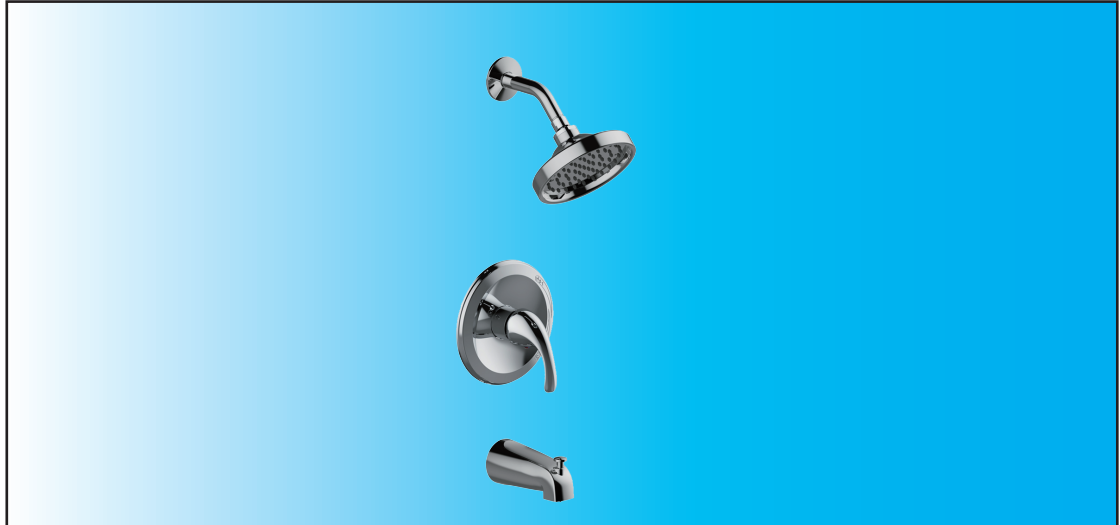

FEATURES & BENEFITS

- Metal Lever Handle
- Metal Shower Arm And Shower Flange
- With Metal Slip On Tub Spout
- With Single Function Showerhead
- Showerhead: Max Flow Rate 1.8 GPM (6.8L/Min)
At 80 PSI (ASME A112.18.1/A112.18.1)

GLL-730CJP
Chrome Finish

GLL-730BNJP
Brushed Nickel Finish

Approvals:

Meets or Exceeds The Following:

- * ANSI/ASME A112.18.1/A112.18.1
- * IAPMO/cUPC
- * ADA Compliant
- * EPA WaterSense



TEL: 888-649-0605

FAX: 877-892-1950

Visit Our Web Site : www.gemlinefaucets.com

□ **GLL-730CJP**

□ **GLL-730BNJP**

gemline

Single Handle Tub & Shower Trim Kit

No.	Name	Part No.
1	Shower head / Cabezal de la ducha	RP38513*
2	Shower arm / Brazo de la ducha	RP38408*
3	Shower flange / Brida de la ducha	RP38046*
4	Sleeve / Funda	RP80624*
5	Escutcheon / Placa protectora	RP80610*
6	Escutcheon screw / Tornillo de la placa protectora	RP50190*
7	Handle / Llave	RP13763*
8	Index / Índice	RP10042
9	Spout / Caño	RP33122*

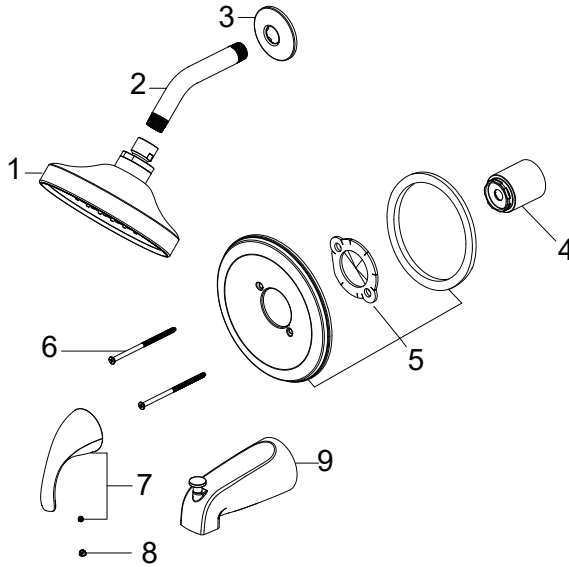

* Specify Finish
* Especifique el Acabado

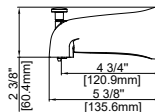
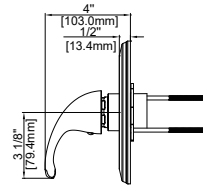
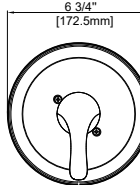
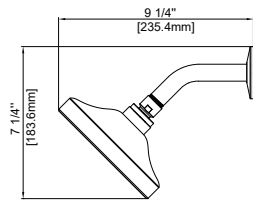
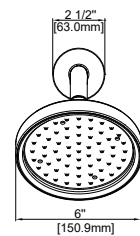

Product Spec Sheet